

CRITICAL REVIEWS OF LOAD FLOW METHODS FOR WELL, ILL AND UNSOLVABLE CONDITION

Amidaddin Shahriari — Hazlie Mokhlis — Ab Halim Abu Bakar *

This paper presents a critical review of Load flow methods in well, ill and unsolvable conditioned systems. The comparison studies deals with multiple load flow solution (MLFS), second-order load-flow (SOLF) and continuation load flow (CLF). The ability of these method to return from unsolvable solution to a solvable solution in load flow analysis is analyzed and discuss thoroughly. Special attention is given to the problems and techniques to provide optimal recommendations of the parameters that are used in these load flow methods. A part of the reviews, this paper also presents the comparison of numerical result using different type of aforesaid load flow methods for well and ill-conditioned systems.

Key words: second-order load-flow, multiple load flow solution, continuation load flow, ill-conditioned system, unsolvable condition

1 NOMENCLATURE

MLFS	Multiple Load Flow Solution
SOLF	Second Order Load Flow
CLF	Continuation Load Flow
NR	Newton Raphson
FDLF	Fast Decoupled Load Flow
X	Vector of uncontrolled (dependent) variables
Y	Vector of controlled (independent) variables
F	Vector function of load flow
ΔX	Correction value vector
S_0	Optimum solution point
λ	Modification coefficient of correction value vector
α, β, γ	coefficient relevant to dependent and independent variables
G	Function of nonlinear inequality constraints
W	Function of nonlinear equality constraints
U	Control variable of independent variables
μ	The multiple load and generator powers
T	Consists (X, Y) and $\in R$
K	Modified vector function of load flow
ΔS	Step-length control in Continuation Load Flow

2 INTRODUCTION

The calculation in obtaining the steady-state condition of powers and voltage at various buses in power system is known as Load Flow (or Power Flow Studies). These studies are of the utmost importance and frequently provide the starting conditions for other power system analysis such as transient stability, fault analysis and contingency analysis. Load flow analysis also is used intensively in the planning of a new power system network or expansion of

existing power system network. Nowadays, load flow analysis is carried out almost exclusively by digital computers and the equations defining the problem are solved by special numerical techniques, which have been developed to suit the special structure of the problem [1, 42]. Due to the important of load flow, many studies in improving load flow solution have been conducted [1, 6, 18, 35].

In the past, the studies in the load flow is more inclined to reduce the analysis time through reducing the iteration number and convergence time [1]. For instance, in [1] and [2], a fast decoupled method was introduced with the objective of reducing the analysis time through simplification of the Newton method equations. However, as the demand of power increasing in early 80's, it was found that the conventional load flow method produced divergence solution for ill-conditioned system [4, 6]. Generally, ill-conditioning system is a system that has weakly-interconnected and a high ratios of lines R/X [7]. Such problem becomes more critical now a day since power system is operating close to their lower security limits [15]. As a result, conventional load flow analysis fails to converge for such system. One of the challenges for ill-conditioned system is to determine whether non-convergence of a power flow is due to failure of the load flow methods or due to infeasible operating point [3, 7].

The objective of this paper is to present a critical review on Load flow methods for well, ill and unsolvable condition. From this review, the causes of non-convergence will be discussed. The review will cover the multiple load flow solution method (MLFS) based on the second order load flow (SOLF) solution in polar coordinates [6, 10, 20] and the continuation load flow (CLF) method for well, ill and unsolvable-conditioned cases respectively [13, 14, 16]. The conducted reviews in this paper is part of on-going research in a power system group

* Center of Research for Power Electronics, Drives, Automation and Control (UMPEDAC), Department of Electrical Engineering, Faculty of Engineering, University of Malaya, 50603 Kuala Lumpur, Malaysia, shahriariamid@yahoo.com

at University of Malaya to develop a new robust load flow method based on second order load flow to solve well, ill and unsolvable conditioned system for a practically large scale power system network. It is expected that the new model has the following features; (a) improve convergence characteristic (b) reduce computational process of load flow analysis.

This paper is organized as follows. In the following section, existing load flow methods in literature are describes briefly. Section 4 presents the mathematical equation involves for the first and second order load flow analysis. Sections 5 and 6 describe the methods on multiple solutions and continuation solutions respectively. Section 7 presents the numerical analysis result that has been carried out for 13 bus ill-conditioned system and standard IEEE 30 bus system. It was found that the SOLF analytic geometry has a better performance in convergence time and mismatch error as compared with the Newton Raphson (NR) in well and ill conditioned system. Finally, conclusion of this paper is presented in Section 8.

3 OVERVIEWS OF LOAD FLOW METHODS

In general, load flow methods can be classified into four main types as follows:

- (1) Conventional load flow method,
- (2) Second-Order load flow method,
- (3) Multiple load flow method,
- (4) Continuation load flow method.

These classifications are based on their purposes in solving different problem condition that will be described in the following section.

3.1 Conventional load flow methods

The earliest computational load flow method was based on Gauss-Seidel method. However, it has poor convergence characteristic and high iteration number. Slow processing speed of a computer at that time also contributed to slow computation time of Gauss-Seidel. Later, the Newton Raphson (NR) method was introduced to improve convergence problem of Gauss-Seidel method [1]. In most typical networks, NR converges within five to six iterations. Despite of that, NR method is only widely accepted in industry when sparsity technique was introduced in 1960s to solve a large scale matrix with high number of zero values [1, 4]. This technique managed to overcome computer memory size, which is low at that time [31].

As power system network size increases dramatically in the early 70's with the increasing demand of energy, NR method started to lose ability to converge fast. Thus, studies at that time were conducted to propose a load flow method that able to converge fast. These issues were addressed by Stott and Alsac when they introduced Fast Decoupled Load Flow (FDLF) method [1], which enhanced computational speed. This method is simplification of NR

method by considering the decoupling characteristic between active power with voltage, and reactive power with angle. It is well-known for its fast convergence characteristic and required minimum memory storage. Nevertheless, when reliability and accuracy, rather than speed of response, was a concern, or when the decoupling principle did not hold, the NR method was the preference [2, 40].

Both methods however, suffered slow convergence or diverge when applied for ill conditioned case. Ill-conditioned case occurs when a system with high ratios of lines R/X , weak interconnection system [2] or heavy loading at some buses [12, 36]. All of these factors affected the stability of both methods. For instance, when a system loading approaches critical loading, sparsity of the Jacobian matrix decreases and the Jacobian matrix tends to become singular [3, 39]. Hence, the possibility of having no solution increases for such system [7, 17]. This issue has led to the development of alternative methodologies, based on the NR iterative scheme such as quadratic format [34].

3.2 Second-order load flow methods

At the end of 70's, second-order load-flow (SOLF) methods were proposed [5, 20]. Second order load flow technique is based on the Taylor series expansion in a polar or rectangular coordinate form. Different from NR method that considered only first order of Taylor series in its formulation, SOLF is considering the second order term of the Taylor series.

In many cases, this second order required lesser iterations, had better convergence characteristics than conventional NR technique [20]. Moreover, it had also been shown that the elements of the second order coefficient matrix need not be stored separately [20].

Rectangular forms of second order method as a fast load flow method retaining nonlinearly was introduced in 1978 by Iwamoto [5, 25]. The proposed method used a fixed or constant matrix throughout the iteration process [33]. Due to its fastness, the method had been used for power system training simulators in Japan [18].

3.3 Multiple load flow solutions methods

In the early 80's, multiple load flow solution (MLFS) methods were proposed [6, 7]. These methods were proposed to address the problem of power system that operates very close to a critical loading condition (voltage collapse) [32, 37, 38]. Such problem is unavoidable due to the increasing demand of power supply without expansion of transmission facilities. Under this situation, conventional load flow of Newton methods most likely diverge. Divergence can also occur when the initial estimation is far from the actual solution [22, 23]. Thus, it is very crucial that a computationally efficient technique be developed to quantify the degree of un-solvability, and also to provide optimal recommendations of the parameters that need to be changed in order to return to a solvable solution [19, 24, 28].

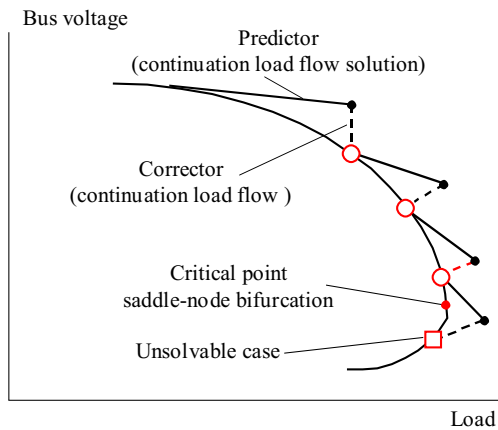

Fig. 1. Sequence of calculation in a multiple load flow solution a continuation load flow method [16]

In general, the MLFS methods used a predictor to determine the best slope that will lead convergence that is from critical initial value to safe margin zone of voltage stability at every iteration as shown in Fig. 1 of voltage-load curve. At the same time, without changing any control variables. Among these methods, Iwamoto and Tamura [6] presented the robust non-divergent load flow methods in well and ill conditioned based on the SOLF Iwamoto method [5].

3.4 Continuation load flow methods

At the end of 80's, the continuation load flow (CLF) was introduced to encounter problem of highly stress contingency situation in a bulk power system [8, 14]. Such problem causes ordinary load flow methods fails to converge. In general, the CLF methods work by modifying the gradient curve of MLFS methods through a corrector as shown in Fig. 1 [16]. The corrector is formulated by changing/controlling the equation related to load demand in order to ensure continuity of power flow solution.

In this type of methods, parameterized load flow equations are solved and the parameter provides an indication whether the system has a solution or not [21]. On other meaning, maximum loading condition of a system as a saddle-node bifurcation is determined by CLF [11, 13, 16]. Furthermore, Fig. 1 shows the unsolvable case where the power flow solution does not exist. In this case, power system is becomes more heavily loaded and caused voltage drop. In this situation, power flow equations have no real solution [13, 27]. The only way to ensure convergence is to introduce compensating devices such as FACT devices [27].

These methods provide optimal recommendations of the dependant and independent variable of power system to return respectively from ill-conditioned to feasible region and unsolvable solution to infeasible region [9, 11, 29].

4 COMPARISON BETWEEN FIRST AND SECOND ORDER OF NEWTON RAPHSON METHOD

4.1 Theoretical Background

The theoretical background of first and second order Newton Raphson formulation is discussed in this section to show its capability and limitation. The power flow problem of an electrical power system can be written as a set of nonlinear equations in the following form

$$F(X, Y) = 0 \quad (1)$$

where

X – vector of uncontrolled (dependent) variables;
 Y – vector of controlled (independent) variables;
 F – vector function of load flow.

For solving (1), a numerical iterative technique needs to be used. The i^{th} iteration of classical NR algorithm based as the first order Taylor series, expansion of $F(X_a, X_b)$ for two variables, *ie* voltage amplitudes and phases as dependant variables at buses, are given as follow

$$F(X_a^i + \Delta X_a^i, X_b^i + \Delta X_b^i) - F(X_a^i, X_b^i) - [\Delta_{X_a, X_b} F]^i [\Delta X_a^i, \Delta X_b^i] \approx 0. \quad (2)$$

Newton's method is very reliable and extremely fast in convergence in well conditioning system. In this condition, the power flow solution exists and is reachable using a flat initial guess (*eg*, all load voltage magnitudes equal to 1.0 per unit and all bus voltage angles equal to 0.0 radian). This case is the most common situation. Thus, numerical Newton method can approach to an optimum point. By starting from an initial guess (X_{-0}, X_{b0}) the series converges towards solution point in the last iteration. The algorithm stops if the variable increments are lower than a given tolerance or the number of iterations is greater than a given limit.

The most important fact in (1) is that only the second derivative exists due to the power flow equation involves two variables *ie* bus voltage and angle and therefore third order term does not exist. By neglecting the high order terms of (1), (2) is an approximation. However, (1) is a quadratic function with respect to the uncontrolled variables [11, 13, 22, 26]. By considering second order term of Taylor series in the Newton Raphson method, SOLF can be expressed as follows

$$F(X_a^i + \Delta X_a^i, X_b^i + \Delta X_b^i) - F(X_a^i, X_b^i) - [\Delta_{X_a, X_b} F]^i [\Delta X_a^i, \Delta X_b^i] - \frac{1}{2} [\Delta X_a^i, \Delta X_b^i]^T [\Delta_{X_a, X_b}^2 F]^i [\Delta X_a^i, \Delta X_b^i] = 0. \quad (3)$$

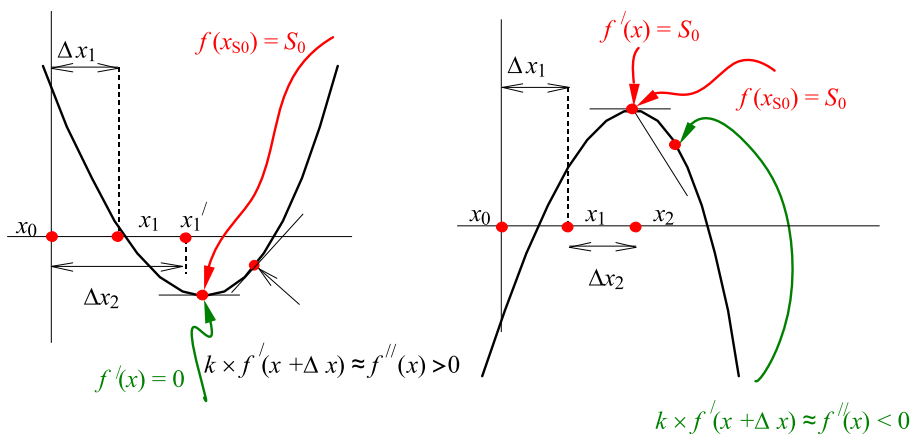

Fig. 2. Comparison of ΔX and performance of the SLOF to approach optimum point

4.2 Advantageous of SOLF method

In order to show the advantageous of SOLF over ordinary NR method, Fig. 2 is considered. These figures illustrate a quadratic function $F(X)$ with respect to uncontrolled variable X for SOLF and NR methods respectively. The main quadratic function $F(X)$ is presented in part C of Equation (9).

The paramount distinction of SOLF to NR method is apparent in (1). Since, (1) is quadric function with respect to $[\Delta X_a, \Delta X_b]$. Therefore, a pair of the correction value indeed exists at each iteration that is given.

$$X_1 = \Delta X_1 + X_0, \tag{4}$$

$$X'_1 = \Delta X_2 + X_0. \tag{5}$$

By having two pair of correction values, the chances of obtaining the new correction value X'_1 that can be greater than X_1 exists. Therefore, as can be seen in Fig. 2 (a), the process towards optimum solution point (maximum and minimum) in SOLF could be faster in as compared to NR method.

Second advantage of SOLF is on its capability to address ill conditioned system. Under this condition, power system operates close to a critical loading (voltage collapse point). As a result, the determinant of Jacobian matrix is zero (singular Jacobian matrix). However, the zero value does not indicate that the solution is approaching an optimum or stable point (voltage stability). In fact it is led to unstable point, which is a saddle point, as illustrated in Fig. 1. For detecting saddle point, the second derivative is necessary. Since the SOLF consist of the second derivative, it is able to recognize this unstable point. Let us, define the second derivative of $F(X)$ respect to X in optimum points in Fig. 2 (a) as

$$\begin{aligned} F''(X) &= \lim_{\Delta X \rightarrow 0} \frac{F'(X + \Delta X) - F'(X)}{\Delta X} \\ &= \lim_{\Delta X \rightarrow 0} \frac{F'(X + \Delta X) - 0}{\Delta X} \\ &\approx \frac{1}{\Delta X} F'(X + \Delta X) \approx k \times F'(X + \Delta X). \tag{6} \end{aligned}$$

Respectively, positive and negative sign of (6) are local maximum and minimum of $F(X)$ at X . The performance of this issue in load flow is corresponding to the Hessian matrix operation [19, 25]. Furthermore, if the Hessian has both positive and negative of Eigen values then, (X_a, X_b) is a saddle point for (1) [16]. Otherwise the Hessian test is inconclusive.

The particular difficulty of SOLF is to calculate of the correction value at each iteration. The quadric matrix of $[\Delta X_a^i, \Delta X_b^i]$ cannot be solved in straightforward manner as same in NR method. For obtaining $[\Delta X_{a_i}, \Delta X_{b_i}]$ a solution of without excessive computer (3) is modified as follows

$$\begin{aligned} F(X_a^i + \Delta X_a^i, X_b^i + \Delta X_b^i) - F(X_a^i, X_b^i) \\ - \frac{1}{2} [\Delta X_a^i, \Delta X_b^i]^T [\Delta^2 X_a, X_b F] [\Delta X_a^i, \Delta X_b^i] \\ = [\Delta X_a, X_b F] [\Delta X_a^i, \Delta X_b^i]. \tag{7} \end{aligned}$$

The main difference between SOLF and NR solving algorithm is apparent in obtaining the $[\Delta X_a^i, \Delta X_b^i]$. In the SOLF, the principal is based on right hand side of equation (7). Indeed $[\Delta X_a^i, \Delta X_b^i]$ at iteration i is determined by $[\Delta X_a^{i-1}, \Delta X_b^{i-1}]$ the left hand side of the equation (7).

The first SOLF's methods in polar and rectangular coordinate used Gauss-Seidel methodology as same as equation (7) [5, 20]. The authors in [6] presented rectangular coordinate of SOLF based on the fixed Jacobian method. The drawback of this method is not applicable for real time analysis since the Jacobian matrix needs to be modified frequently. It means, under this condition each of load flow solution represents a different system in term of its topology and/or status of its regulated buses.

As shown in [15], polar coordinate form of the SOLF [20] provides faster and less requiring storage solution. In addition, the SOLF based on polar formulation performs more reliable that is particularly apparent in a highly stressed system [15, 18]. The set of second terms equations for power mismatch in the SOLF polar form contains twenty elements that each the active or reactive power

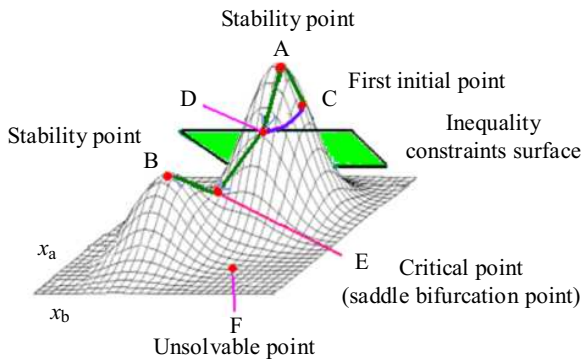

Fig. 3. Illustration of solid geometry of (8) respect to (X, Y) of bus k

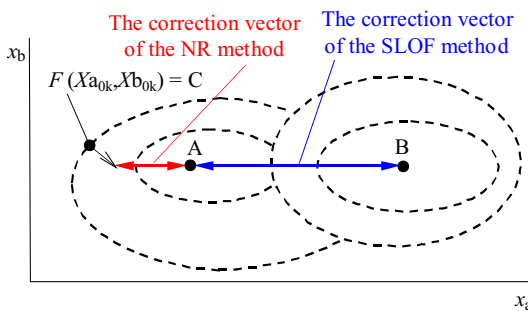

Fig. 4. The contour form of supposed solid geometry of (8) respect to X, Y for bus k

mismatch include ten elements. The numerous numbers of these elements drives calculation of second term matrix very complicate. This paper follows and modifies the SOLF in [20] that neglects the some of these elements that uses in FDLF model. However, the effect of exact polar coordinate form of the SOLF is not being explored yet.

4.3 Convergence characteristic of first and second order Newton method in ill conditioned system

Suppose a load flow equation (1) for a bus k in the i^{th} iteration is given as follows

$$F_k^i(X_{ak}^i, X_{bk}^i, Y_{ak}^i, Y_{bk}^i) = 0. \tag{8}$$

Respectively $X_a, X_b, Y_a, Y_b \in R^n$ correspond to real and imaginary of voltage bus amplitude and injected bus active and reactive power. A quadratic function for bus k is given by [11, 13, 22]

$$\alpha X^2 + \beta X + \gamma = 0. \tag{9}$$

The solution of (9) is a pair of bus k voltage at every iteration. From observation of power flow operation in steady state mode, power system operates as same as fixed point theory. It means the trajectory of studied bus voltage (X) is fixed in optimum or concave point [19, 28]. For simplification of bus k description geometry,

convex form is supposed instead of concave form [34, 39]. According to this hypothesis, solid geometry of (8) can be illustrated in Fig. 3.

Suppose, our initial guess or first operating point is at $F(X_{a0k}, X_{b0k}) = C$, as shown in Fig. 3. By using the SOLF and NR in polar coordinates, after several iterations, two solutions A and B should be located proximate vector $[\Delta X^i]$. Exact and optimum solution of bus k is considered at B . The principal issue is that how to reach solution B , while load flow calculation is converging to solution A . If solution at B exists in extension line vector $[\Delta X^i]$ that crosses point at A , by using the SOLF can approach to solution at B that is shown as $A - B$ segment line as illustrated in Fig. 4. The Fig. 4 is correspondent to the contour form of Fig. 3.

This is because, the Newton method performance is sensitive to the behaviors of the load flow functions and hence to their formulation. The more linear they are, the more rapidly and reliably Newton’s method converges. On the Other hand, non smoothness, *ie*, humps, in any functions of (8) in the region of interest can cause convergence delays, total failure, or misdirection to a non useful solution. The variation of load flow function is correspondent to changing of power system topology from voltage and system frequency stability (well) to instability conditioned such as voltage collapse.

The ill conditioned system is due to the fact that the zone of the power flow solution is far from the initial guess. But, the load flow equations have real solution. The ill conditioning is occurred by adding some equality and inequality constraints as variables and functions to load flow equations that should be satisfied coincidentally. Therefore, a set of nonlinear inequality and equality constraints can be given as [28]

$$G(X, Y, U) \leq 0, \tag{10}$$

$$W(X, Y, U) = 0. \tag{11}$$

U is control variable of independent variables that includes Q -limit violation, generate outage, newly-turned on generator and so on. Figure 3 depicts a supposed typically system constraint as approximately flat surface. The geometric concept of supposed surface performance is to decline the purpose solution point A to point D . Moreover, operating power system close to its security margins that occurs in heavy loaded in planning application and contingency analysis leads system to unsolvable cases. This operation is that by increasing load demand, point A , forced to locate in the boundary region, accordingly by becoming more highly stress is dropped in unsolvable region that are supposed at points E and F in Fig. 3 respectively. Nevertheless, the number of situations that the load flow equations have no real solution increases. As was mentioned in previous section, to approach solution at B is accomplished under concept of Multiple and Continuation Load flow model, as, the optimal direction, to move in dependent and independent variable space to return to power flow solvability zone [13, 14, 17].

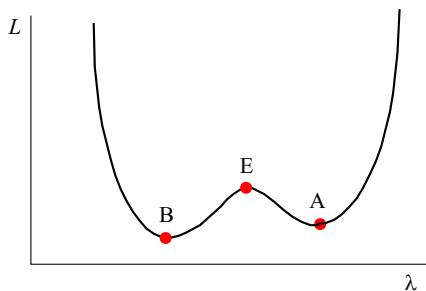

Fig. 5. Illustration of scalar cubic of (13) respect λ

5 MULTIPLE LOAD FLOW SOLUTION METHOD

Multiple Load Flow Solution (MLFS) methods was presented, as predictor, check best slope from a critical point from critical initial value to safe margin zone of voltage stability at each step to be convergence without changing control (independent) variables [6, 7, 30]. On other meaning, the predictor is to adjust the size of vector $[\Delta X_i]$ and specifying optimal value to takes a step towards the best stability solution in ill conditioned system, *ie* solution at *B* in Figs. 3 and 4. Hence, the modification of step update is formulated as follows

$$X^{i+1} = X^i + \lambda \Delta X^i. \tag{12}$$

Rewriting (3) with the scalar multiplier gives

$$F(X_a^i + \Delta X_a^i, X_b^i + \Delta X_b^i) - F(X_a^i, X_b^i) - \lambda^i [\Delta X_a, X_b F] [\Delta X_a^i, \Delta X_b^i] - \frac{1}{2} \lambda_i^2 [\Delta X_a^i, \Delta X_b^i]^T [\Delta^2 X_a, X_b F] [\Delta X_a^i, \Delta X_b^i] = 0. \tag{13}$$

By plotting scalar cubic of (13) as objective function (*L*) that is given in (14), respect to λ is shown the practically a pair concave steady state point (local minimum) and a saddle point (local maximum) that respectively correspond to *A, B* and *E* in Fig. 3.

$$L = |F(X^i + \Delta X^i, X^i + \Delta X^i) - F(X^i, X^i) - \lambda^i [\Delta X, Y F]^i [\Delta X^i, \Delta Y^i] - \lambda^i \frac{1}{2} [\Delta X^i, \Delta Y^i]^T [\Delta^2 X, Y F]^i [\Delta X^i, \Delta Y^i]|. \tag{14}$$

If a system has a pair of near solution, then according to Fig. 5, the degree of polynomial of (14) differentiation respect to λ becomes three. In this situation three real roots, are exist for $\partial L / \partial \lambda$. In ascending order to roots, suppose λ_1, λ_2 and λ_3 . That are correspond to *A, E* and *B* as concave stability solution for *A* and *B* and bifurcation solution point *E* as well as instability solution in real power system.

MLFS method is a nonlinear programming problem that based on the optimal multiplier [11, 39]. Although, several methods were presented that deal with MLFS, but most of them the computation of MLFS methods require more analytic effort [9, 10, 12, 21]. Another difficulty for MLFS is apparent in defining maximum loading level that system can supply for unsolvable case [41].

6 THE CONTINUATION POWER FLOW METHOD

Continuation load flow Load (CLF) was introduced to determine the voltage collapse as it main objective. By doing this, the boundary zone of maximum active and reactive could be detected and hence power load demand could be controlled. In order to achieve this requirement, gradient curve of MLF needs to be modified as shown in Fig. 1. Typically, it means that the loading level of the network is too high then CLF can define correspond loading level and generator power. A simple method for inserting load parameter is to define as constant power load model [15, 16, 41].

The modified and depended (1) on scalar parameter μ is

$$K(T, \mu) = 0 \tag{15}$$

where $T \in R$ that T consists of (X, Y) and μ present the multiple load and generator powers

$$0 \leq \mu \leq \mu_{critical}. \tag{16}$$

Differentiating (16) at a generic steady state point is as follows

$$\frac{\partial K(T, \mu)}{\partial T} dT + \frac{\partial K(T, \mu)}{\partial \mu} d\mu = 0. \tag{17}$$

Then, corrector step is given by

$$\frac{dT}{d\mu} = - \frac{\partial K(T, \mu)}{\partial \mu} \times \frac{\partial K(T, \mu)^{-1}}{\partial T}. \tag{18}$$

By adding the correction value to initial solution, next approximate solution is expressed

$$K(T + \Delta T, \mu + \Delta \mu) = K(T, \mu) + \frac{dT}{d\mu} \Delta \mu. \tag{19}$$

From (19), it is apparent that the used optimization method in CLF is based on the decent gradient method [34].

In order to apply a locally parameterized continuation technique to the power flow problem, a load parameter must be inserted into the equations. As there are many ways this could be done, only a simple example using a constant power load model has been be considered in this paper. Since, predominance of the CLF for unsolvable cases is obvious in remaining well conditioned and around the critical point by getting the part of the studied bus voltage versus its load or *P-V* or *Q-V* curve in Fig. 1 or in Fig. 5 to define maximum loading level. In this sense, it is considered as a constrain equation of the step size along the length of the got part of (15) as follows

$$(T_i - T_i(critical))^2 + (\mu_i - \mu_i(critical))^2 = \Delta S^2. \tag{20}$$

where ΔS a step-length control to trace the new solution on the part curve to find critical point (voltage instability solution point). In geometrically concept, to modify path of convergence in point *B* from *C-D-E-B*, instead of the path of *A-D-E-B*. Furthermore CLF is used to determine peak load demand as boundary region between ill conditioned and unsolvable region [35].

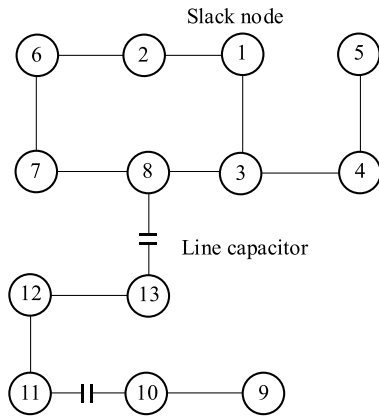

Fig. 6. The line diagram of 13 bus ill-conditioned system

Table 1. The performance of the NR method for solving IEEE 30

Iteration	CPU time(s)	Max error
1	0.25	1.88001
2	0.281	0.0120031
3	0.328	0.00109039
4	0.356	0.00014524

Table 2. The performance of the SOLF method for solving IEEE 30

Iteration	CPU time(s)	Max error
1	0.156	1.88001
2	0.188	0.012005
3	0.234	0.00107524
4	0.266	7.94985e-09

Table 3. The performance of the SOLF method for solving 13-bus ill conditioned system

Iteration	CPU time(s)	Max error
1	0.047	1.00203
2	0.078	4.36341
3	0.094	3.00225
4	0.109	0.905509
5	0.125	0.405434

7 THE CONTINUATION POWER FLOW METHOD

For testing the NR, SOLF in polar coordinate and the CLF method, the IEEE 30 bus test system and 13bus ill-conditioned system are used. The NR, SOLF and CLF were written in C++ and the analysis was done over PC with the specification of Dual-Core AMD Opteron, 2 GHz, 2 GB RAM. For well conditioned, the IEEE 30 bus system is used to examine the effect SOLF in polar coordinate on the convergence time execution and the convergence mismatch. Tables 1 and 2 show the CPU time and maximum power mismatch in every iteration for the NR and SOLF respectively.

It can be noted that the CPU time of computation for each iteration in SOLF is faster than NR method.

Thus, the SOLF is converging faster than NR method. It can also be seen that the mismatch vector for SOLF in every iteration is smaller than NR method. This shows that SOLF is more accurate load flow model as compared to NR method.

The 13 bus ill-conditioned system is depicted in Fig. 6. This system is considered ill-conditioned because of certain radial system type, the heavy buses loading, the position of the slack-generator and the two series capacitors.

These characteristics forces jacobian matrix in load flow becomes singular. Therefore, eigenvalues of the studied ill- conditioned system's jacobian matrix are very sensitive to small changing in its variable state (dependent) variables. The corresponding sparse jacobian matrix is depicted in Fig. 7. Also, solid geometry of sparse jacobian matrix as conical in diagonal elements of jacobian matrix is shown in Fig. 8.

Under this condition, ratio of maximum eigenvalue to minimum eigenvalue as condition the number of the jacobain is very high, in the studied ill system the ratio is 1000. This leads to round off error agglomerations during the course of iterative solution and may give rise to oscillations or divergence of power flow solution.

The tests result for the 13 bus-ill conditioned system tested using SOLF is given in Table 3.

This is clear from the result that for converging, approached mismatch value in the last iteration is far away from 0.0001 (a common mismatch error). Thus, SOLF and NR fail to converge.

For returning the ill conditioned system to solvable solution, the CLF has been used. Continuation power flow defines active and reactive power limitations to control buses angles and voltage amplitude power line flow. Therefore, Bus 13, in vicinity of heavy load demanding in Bus 12 and series capacitor in line 13-8, is used to illustrate the effect of the CLF on critical point as voltage instability for Bus 13. The effect of CLF is illustrated in Fig. 9.

As can be seen by increasing the reactive power demand at Bus 13, the voltage at Bus 13 is also increasing. It means the CLF method try to increase and maintain voltage amplitude at Bus 13 to acceptable level of ill conditioned system. However, from 1.6 p.u of reactive power, the voltage drop significantly. At 1.8 p.u of reactive power, the voltage becomes $V = 0.892$ p.u. After this point, the system leads to unsolvable condition. Thus, by knowing this critical point, we can ensure that the load flow will converge.

7 CONCLUSION

In this paper, first order Newton Raphson and second order Newton Raphson load flow methods, were reviewed in term of convergence characteristics and mismatch vector, in well and ill conditioned system. From the reviewed, it was shown that second order load flow able to detect ill

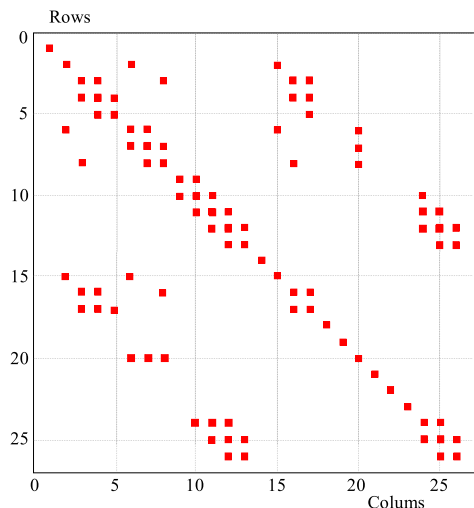

Fig. 7. Sparse jacobian matrix for 13bus ill-conditioned system

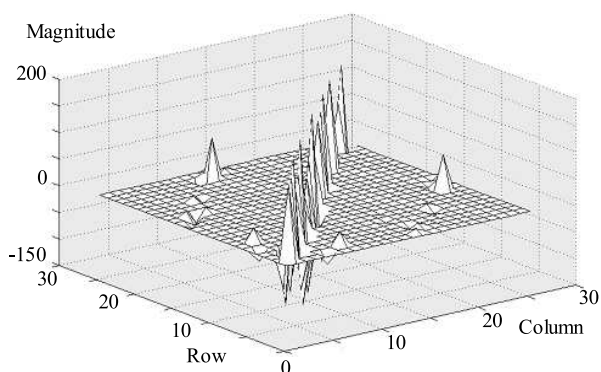

Fig. 8. Solid geometry of sparse jacobian matrix of 13 bus ill-conditioned system

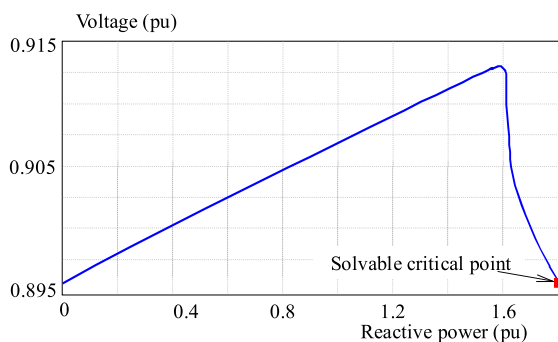

Fig. 9. The performance of CLF in defining critical point of Bus 13

conditioned problem during load flow process. However, convergence is not guaranteed for ill conditioned system. Latter, the reviewed of multiple load flow method shows that the method able to convergence for ill conditioned system by using a predictor. However, the predictor only able to direct the solution up to a critical point of solvable zone. For unsolvable condition, Continuation load flow has the advantage to lead the system to solvable condition by providing the maximum load demand allowable for ill conditioned system.

In order to study the SOLF effectiveness the method has been tested using IEEE 30 bus test system and 13 bus ill-conditioned system. It was found that SOLF is more superior to NR method in term of convergence and solution time. However, the test shows that SOLF diverges in ill conditioned system. In this case, CLF need to be used to determine critical point for solvable solution for ill conditioned system.

Acknowledgements

This work is supported by the Ministry of Science, Technology and Innovation of Malaysia (e-science fund: 06-01-03-SF0562) and the University of Malaya, Malaysia.

REFERENCES

- [1] STOTT, B.: Review of Load-Flow Calculation Methods, Proc. IEEE **62** No. 1 (July 1974), 916-929.
- [2] WU, F. F.: Theoretical Study of the Convergence of the Fast Decoupled Load Flow, IEEE Trans. Power Syst. **96** No. 2 (Jan/Feb 1977), 269-275.
- [3] LUO, G. X.—SEMLYEN, A.: Efficient Load Flow for Large Weakly Meshed Networks, IEEE Trans. Power Syst., **5** No. 4 (Nov 1990), 1309-1316.
- [4] STOTT, B.: Effective Starting Process for Newton-Raphson Load Flows, IEEE Trans. Power App Proc. Inst. Elect. Eng. **118** No. 8 (Nov 1971), 983-987.
- [5] IWAMOTO, S.—TAMURA, Y.: A Fast Load Flow Method Retaining Nonlinearity, IEEE Trans. Power App. Syst. **97** No. 1 (Sep/Oct 1978), 1586-1599.
- [6] IWAMOTO, S.—TAMURA, Y.: A Load Flow Calculation Method for Ill Conditioned Power Systems, IEEE Trans. Power App. Syst. **100** No. 3 (Apr 1981), 1736-1743..
- [7] TRIPATHY, S. C.—PRASAD, G. D.—MALIK, O. P.—HOPE, G. S.: Load-Flow Solutions for Ill-Conditioned Power Systems by a Newton-Like Method, IEEE Trans. Power App. Syst. **101** No. 1 (Oct 1982), 3648-3657.
- [8] SCHAFFER, M. D.—TYLAVSKY, D. J.: A Nondiverging Polar Form Newton-Based Power Flow, IEEE Trans. Ind. App. **24** No. 1 (Sep /Oct 1988), 870877.
- [9] BRAZ, L. M. C.—CASTRO, C. A.—MURARI, C. A. F.: A Critical Evaluation of Step Size Optimization Based Load Flow Methods, IEEE Trans. Power Syst. **15** No. 1 (Feb 2000), 202-207.
- [10] TATE, J. E.—OVERBYE, T. J.: A Comparison of the Optimal Multiplier in Polar and Rectangular Coordinates, IEEE Trans. Power Syst. **20** No. 4 (Nov 2005), 1667-1674.
- [11] IBA, K.—SUZUKI, H.—EGAWA, M.—WATANABE, T.: A Method for Finding a Pair of Multiple Load Flow Solutions in Bulk Power Systems, IEEE Trans. Power Syst. **5** No. 2 (May 1990), 582-591.
- [12] OVERBYE, T. J.—KLUMP, R. P.: Effective Calculation of Power System Low-Voltage Solutions, IEEE Trans. Power Syst. **11** No. 1 (Feb 1996), 75-82.
- [13] OVERBYE, T. J.: A Power Flow Measure for Unsolvable Cases, IEEE Trans Power Syst. **9** No. 3 (Aug 1994), 1359-1365.
- [14] AJJARAPU, V.—CHRISTY, C.: The Continuation Power Flow: A Tool for Steady State Voltage Stability Analysis, IEEE Trans. Power Syst. **7** No. 1 (Feb 1992), 416-423.
- [15] MILANO, F.: Continuous Newton's Method for Power Flow Analysis, IEEE Trans. Power Syst. **24** No. 1 (Feb 2009), 50-57.
- [16] AVALOS, R. J.—CAÑIZARES, C. A.—MILANO, F.—CONEJO, A.: Equivalency of Continuation and Optimization Methods to Determine Saddle-Node and Limit Induced Bifurcations

- in Power Systems, *IEEE Trans. Power Cir. Syst.* **56** No. 1 (2009), 210–223.
- [17] de SOUZA, A. Z.—CAÑIZARES, C. A.—QUINTANA, V. H.: New Techniques to Speed Up Voltage Collapse Computations Using Tangent Vector, *IEEE Trans. Power Syst.* **12** No. 3 (Aug 1997), 1380–1387.
- [18] KEYHANI, A.—ABUR, A.—HAO, S.: Evaluation of Power Flow Techniques for Personal Computers, *IEEE Trans. Power Syst.* **4** No. 2 (May 1989), 817–826.
- [19] VENIKOV, V. A.—STROEV, V. A.—IDELCHICK, V. I.—TARASOV, V. I.: Estimation of Electrical Power-System Steady State Stability, *IEEE Trans. Power App. Syst.* **94** No. 3 (1975), 1034–1041.
- [20] SACHDEV, M. S.—MEDICHERLA, T. K. P.: A Second Order Load Flow Technique, *IEEE Trans. Power App. Syst.* **96** No. 1 (Feb 1977), 189–197.
- [21] LI, S. H.—CHIANG, H. D.: Continuation Power Flow With Nonlinear Power Injection Variations: A Piecewise Linear Approximation, *IEEE Trans. Power Syst.* **23** No. 4 (Nov 2008), 1637–1643.
- [22] WILSON LONG, R.: Inherent Constraints Control Convergence: A New Method in the Long Look at Load Flow, *IEEE Trans. Power App. Syst.* **88** No. 4 (Jan 1969), 22–27.
- [23] BIJWE, P. R.—KELAPURE, S. M.: Nondivergent Fast Power Flow Methods, *IEEE Trans. Power Syst.* **18** No. 1 (May 2003), 633–638.
- [24] SASSON, A. M.: Nonlinear Programming Solutions for Load-Flow, Minimum Loss, and Economic Dispatching Problems, *IEEE Trans. Power App. Syst.* **88** No. 4 (Apr 1969), 399–409.
- [25] HUBBI, W.: The Mismatch Theorem and Second-Order Load-Flow Algorithms, *IEE Proc.* **132** No. 4 (July 1985), 189–194.
- [26] WAMSER, R. J.—SLUTSKER, I. W.: Power Flow Solution By Newton-Raphson Method In Transient Stability Studies, *IEEE Trans. Power App. Syst.* **103** No. 8 (Aug 1984), 2299–2307.
- [27] RIVAS. R. LAND ULLOD. C. L.: Automatic Blackout Recovery through a Deterministic Load Flow, *The International Conference on Power Engineering Society Transmission and Distribution*, IEEE 2006 – Venezuela.
- [28] STOTT, B.—MARINHO, J. L.: Linear Programming for PowerSystem Network Security Applications, *IEEE Trans. Power Syst.* **98** No. 4 (May/June 1979), 837–848.
- [29] CHEN, Y.—SHEN, C.: A Jacobian-Free Newton-GMRES(m) Method with Adaptive Preconditioner and its Application for Power Flow Calculations, *IEEE Trans. Power Syst.* **21** No. 3 (Aug 2006), 1096–1103.
- [30] TAMURA, Y.—MORI, H.—IWAMOTO, S.: Relationship between Voltage Instability and Multiple Load Flow Solutions in Electric Power Systems, *IEEE Trans. Power App. Syst.* **102** No. 5 (May 1983), 1115–1125.
- [31] SASSON, A. M.—TREVINO. C.—ABOYTES. F.: Improved Newton's Load Flow Through a Minimization Technique, *IEEE Trans. Power App. Sys.* **90** No. 3 (Feb 1971), 1974–1981.
- [32] ALVES, D. A.—da SILVA, L. C. P.—CASTRO, C. A.—da COSTA, V. F.: Continuation Fast Decoupled Power Flow with Secant Predictor, *IEEE Trans. Power Syst.* **16** No. 3 (Aug 2003), 1078–1085.
- [33] SEMLYEN, A.—de LE'ON, F.: Quasi-Newton Power Flow Using Partial Jacobian Updates, *IEEE Trans. Power Syst.* **16** No. 3 (Aug 2001), 332–339.
- [34] JABR, R. A.: A Conic Quadratic Format for the Load Flow Equations of Meshed Networks, *IEEE Trans. Power Syst.* **22** No. 4 (Nov 2007), 2285–2286.
- [35] WANG, Y.—da SILVA, L. C. P.—WILSON XU: Investigation of the Relationship between Ill-Conditioned Power Flow and Voltage Collapse, *IEEE Power Engineering Review* **20** No. 4 (July 2000), 43–45.
- [36] YORINO, N.—HUA-QIANG LI SASAKI, H.: A Predictor/Corrector Scheme for Obtaining Q-Limit Points for Power Flow Studies, *IEEE Trans. Power Syst.* **20** No. 2 (Feb 2005), 130–137.
- [37] DIMITROVSKI, A.—TOMSOVIC, K.: Boundary Load Flow Solutions, *IEEE Trans. Power Syst.* **19** No. 1 (Feb 2004), 348–355.
- [38] SODE-YOME, A.—MITHULANANTHAN, N.—LEE, K. Y.: A Maximum Loading Margin Method for Static Voltage Stability in Power Systems, *IEEE Trans. Power Syst.* **21** No. 3 (May 2004), 799–808.
- [39] GUEDES, R. B. L.—ALBERTO, L. F. C.—BRETAS, N. G.: Power System Low-Voltage Solutions using an Auxiliary Gradient System for Voltage Collapse Purposes, *IEEE Trans. Power Syst.* **20** No. 3 (Aug 2005), 1528–1537.
- [40] NOR, K. M.—MOKHLIS, H.—GANI, T. A.: Reusability Techniques in Load Flow Analysis Computer Program, *IEEE Trans. Power Syst.* **19** No. 4 (Nov 2004), 1754–1762.
- [41] HASANPOUR, S.—GHAZI, R.—JAVIDI, M. H.: A New Method for Fast Computation of Maximum Loading Margin Utilizing the Weak Area of the System, *International Review of Electrical Engineering (IREE)* **4** No. 1 (Feb 2009), 139–145.
- [42] ZHOU, E. Z.: Object-Oriented Programming, C++ and Power System Simulation, *IEEE Trans. Power Syst.* **11** No.1 (Feb 1996), 206–215.

Received 24 April 2012

Amidaddin Shahriari received his BEng in Electrical Engineering in 2005 from Tehran South Islamic Azad University and MEng in 2007 from Iran University of Science Technology (IUST). Now, he is working towards the PhD degree in the University of Malaya. His main research interest is in numerical analysis of power system performance.

Hazlie Mokhlis received his BEng in Electrical Engineering in 1999 and MEng in 2002 from University of Malaya, Malaysia. His obtained PhD degree from the University of Manchester, UK in 2009. Currently he is a senior lecturer in the Department of Electrical Engineering, University of Malaya. His main research interest is in distribution automation area and power system protection.

Ab Halim Abu Bakar received his BSc in Electrical Engineering in 1976 from Southampton University UK and MEng and PhD from University Technology Malaysia in 1996 and 2003. He has 30 years of utility experience in Malaysia before joining academia. Currently he is a lecturer at the Department of Electrical Engineering, University of Malaya, Malaysia.