

A Novel TVA-REPSO Technique in Solving Generators Sizing Problems for South Sulawesi Network

Abstract. This paper present a novel optimization method, Time Varying Acceleration – Rank Evolutionary Particle Swarm Optimization (TVA-REPSO) in solving optimum generator sizing for minimising power losses in the transmission system of South Sulawesi, Indonesia. A comparison between the proposed method and three other methods was done in order to find the best method to optimize the generators' output size. The results show that the TVA-REPSO algorithm can obtain the same performance as PSO but it only required shorter computing time and can converges faster than the original PSO.

Streszczenie. W artykule przedstawiono matematyczną metodę rozwiązania zagadnienia znalezienia optymalnego rozmiaru generatora, w celu minimalizacji strat w elektroenergetycznym systemie przesyłowym Południowej Sulawesi w Indonezji. W algorytmie wykorzystano optymalizację roju cząstek ze zmiennym w czasie przyspieszeniem (ang. TVA-REPSO). Dokonano porównania z innymi metodami, pokazało, że opracowana metoda ma skuteczność podobną do klasycznej metody PSO, lecz krótszy czas obliczeń. (Nowoczesna technika TVA-REPSO w rozwiązaniu zagadnienia doboru rozmiarów generatora w sieci elektroenergetycznej Południowej Sulawesi).

Keywords: Generators' optimal Output, Optimization Method, Power Loss Reduction, Voltage Stability Index

Słowa kluczowe: optymalna praca generator, metoda optymalizacji, redukcja strat mocy, współczynnik stabilność napięcia.

Introduction

Transmission line is an important part in the power system that connects the power utilities to the consumers. Since the transmission line is operated in high voltage and in mesh configuration, the system will allow the transmission line to transfer a bulk of power to the load's sides [1]. However, with the huge amount of power transferred from one location to other locations, the power losses in the network will also increase, and at the same time, reduce the efficiency of the transmission system. Many strategies have been used to improve the efficiency of the transmission network such as by installing the Static VAR Compensator (SVC) or capacitor bank [2-4], adjusting the tap setting at the transformer side [5], implementing Interline Power Flow Controller (IPFC) through the network [6] and etc. However, a proper technique is required to allocate all these devices in order to obtain the maximum benefit either using a mathematical approached [7-9] or optimization approached [10-12].

In [13] for example, the authors have used an optimization method which is Genetic algorithm (GA) to allocate the reactive power compensation in the network. The optimization method will help to indicate the optimal placement for allocating the reactive power compensators by taking the power losses minimization as the objective function. Not only that, by adding the others constraint to the algorithm such as voltage stability index [14], it will make the system to operate in a lower power losses within a stable condition. Therefore, the authors [14] used the L-Index as a stability indication, SVC as the reactive power compensation and also included the economics factors in the analysis. The other methods that can be used to have lower power losses in the system is by injecting a new generator units in the network and near to the concentrated loads area. However, since the total cost to build a new generator is very high, the use of other alternative methods to improve the transmission line's performance is more practical.

Different scenario occurred to the South Sulawesi Transmission System (SSTS). The installation of new generator units is required in this system to fulfil the demand of the system especially for the short term load increment. It is due to the differences on power generation and demand that occurred in the system. Nowadays, almost every day, the power utilities in SSTS need to do the load

shedding to fulfil the power demand. Therefore, the used of SVC, IPFC, tap transformer and others devices were not very significant for this network. The government has decided to install 2 units of generator which will be located in the Barru and the Jeneponto areas, in order to increase the reliability and efficiency of the network. The maximum capacities of generator units are 100MW and 250MW respectively. Although the installation of new generators could improve the reliability of the supply, without the proper sizing, it will give a negative impact to the network in terms of power losses, voltage profile, stability and etc.

Therefore, in this research, a comparison between the proposed novel method, Time Varying Acceleration –Rank Evolutionary Particle Swarm Optimization (TVA-REPSO) and others well known optimization methods such as, Particle Swarm Optimization (PSO), Evolutionary Programming (EP) and Artificial Immune System (AIS), will be done in order to verify the effectiveness of the proposed method. The performance of the algorithms will be assessed in terms of their ability to search for the optimal generators output, the minimum power losses value and the computation time.

TVA-REPSO Optimization Technique

A novel Optimization method which is Time Varying Acceleration – Rank Evolutionary Particle Swarm Optimization (TVA-REPSO) is introduced in this paper. The hybridization of Evolutionary Programming (EP) with Particle Swarm Optimization (PSO) method (known as REPSO) will enhance the computing time of original PSO. It is due to the "ranking" concept that is used by EP in the PSO algorithm for selecting the best results to be maintained along the optimal searching process. Fig. 1 shows the pseudo code to hybridize the EP in the PSO algorithm. From the coding, the combination, ranking and selection process at the middle of PSO algorithm (step 5) will make some of the particles been terminated while the best results will maintain in the next iteration. This idea has made the REPSO algorithm to move faster to the optimal point compared to original PSO.

Besides that, the original PSO consist of two acceleration constant, c_1 and c_2 and known as cognitive and social parameters, which will affect the performance of PSO if both constant values are not suitable. An unsuitable value of acceleration constant might cause the algorithm to fail

from obtaining the convergence value. Therefore, in the Time Varying Acceleration- Rank Evolutionary Particle Swarm Optimization (TVA-REPSO), the variations of acceleration coefficient configurations with respect to the iteration number will give the TVA-REPSO chances to balance the relationship between cognitive coefficient impact and the social coefficient impact. The range for both acceleration coefficients is tested several times and the best range for the TVA-REPSO is in between 0.2 to 1.8. By using this idea, the equation for cognitive (c_1) – social (c_2) parameters implemented in TVA-REPSO are:

$$(1) \quad c_1 = (c_{1f} - c_{1i}) * \left(\frac{iter}{iter_{max}} \right) + c_{1i}$$

$$(2) \quad c_2 = 2 - c_1$$

where: $c_{1f} = 1.8$; $c_{1i} = 0.2$;

From (1) and (2), the value of c_1 and c_2 are always changes when the number of iteration is increased. Let the maximum iteration number is 200, the pattern of c_1 and c_2 is shown in Fig. 2. From the figure, the value of c_2 is at the maximum value during the initial iteration and gradually decreases when the number of iteration increases. Meanwhile the value of c_1 is at minimum value during the initial iteration and steadily increases with respect to the iteration number.

By having this coefficient acceleration pattern, all the particles are focusing on social best results at the initial stage and change to the cognitive best results at the end of the process. Therefore, if the initial random number (particle) is far from the optimal solution, the highest c_2 value will bring the particle to the optimal value in a faster rate and when the particle is close to optimal results (at high iteration), the highest c_1 value at final iteration will help the algorithm to find the best results around the solution area. Inversely, if the value of c_1 , at the initial iteration, is higher than the value of c_2 (reverse condition), the particles will only focus on its own cognitive best solution, hence, slowing down their movements toward the global best/solution.

Step 1 Randomize N number of Generators (Gen) size
Check random number fulfils all the constraints or not.
if yes then
Save the Gen size
else
Delete and re-randomize new Gen size
end if

Step 2 Calculate the Power Losses for successful population

Step 3 Determine the G_{best} and P_{best} , based on the Power Losses value.

Step 4 Find the new Gen sizes (X^{new}) from the velocity value (v_i)
Check the X^{new}
if $X^{new} < X_{max}$ **or** $X^{new} > X_{min}$ **then**
Proceed with the Gen size
else
Assigned the $X^{new} = X_{max}$ for $X^{new} > X_{max}$
Assigned the $X^{new} = X_{min}$ for $X^{new} < X_{min}$
end if

Step 5 Combined the previous population (X) with the new population (X^{new})
Sort the population based on the Power Losses value
Select the top N Gen sizes as the successful population,

Step 6 Check the stopping criteria
if all population give the similar results **then**
Stop and show the optimal results
else if iteration number $> iter_{max}$ **then**
Stop and show the optimal results
else
Continue to **Step 4**
end if

Fig. 1 Pseudo code of TVA-REPSO

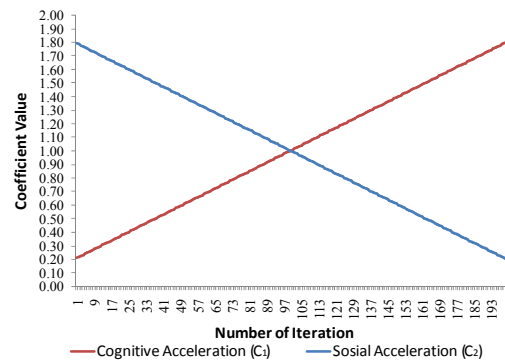

Fig.2. The acceleration coefficient pattern in TVA-REPSO

With the varying acceleration coefficient concept in TVA-REPSO, the process for the algorithm to find the global optimal solution will be faster. Fig. 3 illustrates the effect of c_1 and c_2 to the performance of TVA-REPSO and Fig. 4 shows the flow chart of TVA-REPSO in obtaining the optimal generator output in this study respectively. The formulae to find the new velocity and next particles position in the TVA-REPSO are remaining same as the original PSO which are shown in (3) and (4)

$$(3) \quad v_i^{k+1} = \omega v_i + c_1 r_1 (P_{best}^k - x_i^k) + c_2 r_2 (G_{best}^k - x_i^k)$$

$$(4) \quad x_i^{k+1} = v_i^{k+1} + x_i^k$$

where: c_1 and c_2 – cognitive and social parameter constant; r_1 and r_2 – random numbers with a range of $[0,1]$; P_{best}^k – the best position particle achieved based on its own experience; G_{best}^k – the best particle position based on swarm's overall experience; k – the iteration index.

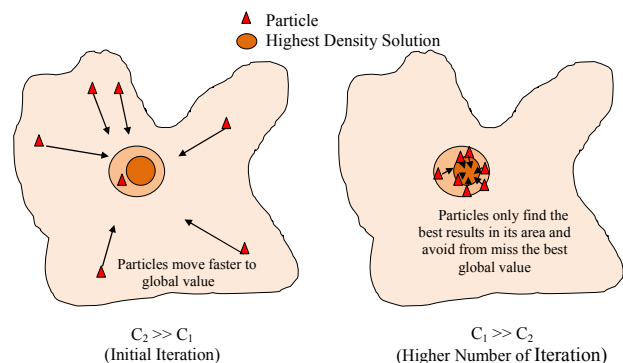

Fig.3. The effect of c_1 and c_2 to performance of TVA-REPSO

Results and Discussions

South Sulawesi electrical systems can generally be separated into 2 sub-systems which are the North and South Sub-System as shown in Fig. 5. North central section consists of a large generation centre with low operating costs (Bakaru, Sengkang and Suppa), whereas in the South Sub-Station, the thermal generating units with expensive cost operations is more dominant. This leads to the high power transfer from the north area to the south area in obtaining cheaper cost of generation, which can be proved by using the load flow analysis. From the results, at the normal operating conditions, the power transferred from the north area (bus 15) to the south area (bus 1) was 143.97 MW which is near to 37 percent from total generation capacity of all units at the north area (bus 17, bus 24 and bus 31). The high power transfer between these 2 regions causes the high losses existing in the system, even though the cost of generation is low.

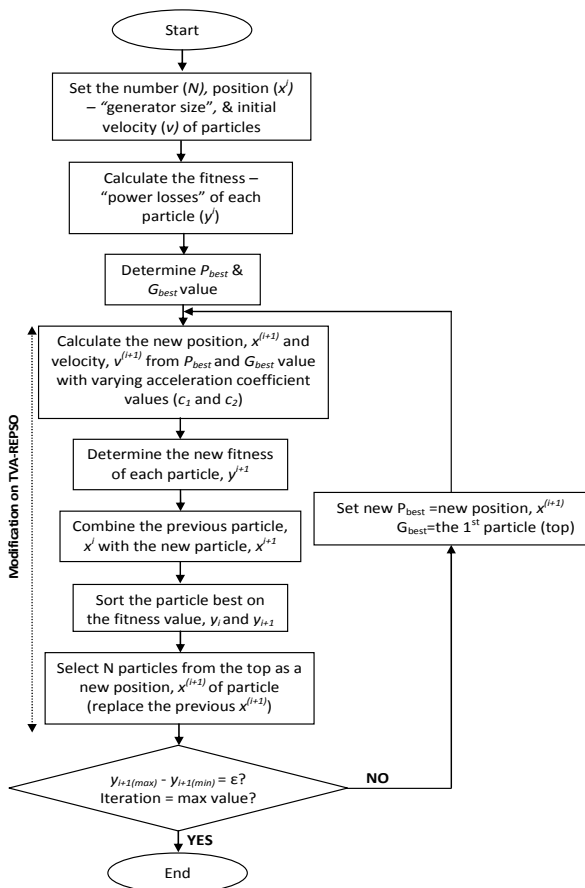

Fig.4. TVA-REPSO process to find generators' optimal output

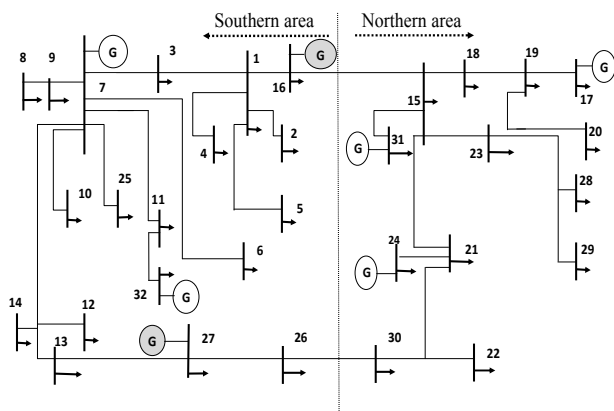

Fig.5. New South Sulawesi Transmission System Layout

Due to this problem, the government has planned to build a new power plant in the Barru area (bus 16) and the Jeneponto area (bus 27) which is located at the southern part of South Sulawesi's electrical system (shaded generators). The total generations capacity at buses 16 and 27 are 100MW and 250 MW respectively. Even though the total capacity of both generators seems to be sufficient enough, it should be noted that both generators will not be operated at maximum capacity due to some limitations in power system such as power losses increment, stability of the network, voltage profile and others. The power losses of the network will increase and the system might collapse without the proper generator output configuration. Thus, in this study, 3 different well known optimization methods are used and compared with the proposed algorithm in determining the optimal generation output for reducing the existing power losses. The performance of these

optimization methods will be evaluated in terms of their ability to obtain the optimal generator capacity, the total computation time required as well as the new power losses value in the system.

Table I shows the performance of EP, AIS, PSO and TVA-REPSO algorithms in sizing the two new units of generator in the South Sulawesi transmission line system. By assuming the existing generators' capacity is maintained, both new generators' capacity will give an impact to the new power losses value in the network. From the results, it can be clearly seen that the ability of AIS and EP in finding the optimal size of generators and searching the minimum power losses is similar. By operating the generator at bus 16 at 84.141 MW and bus 27 at 53.172 MW, the power losses in the network is reduced from 23.4120MW to 10.5150MW which is nearly 55 percent of reduction. However, the AIS required only 25.61 seconds or 3 iterations to achieve the results while the EP required the maximum iteration (200) to obtain this value. Therefore, although the generators' output given by these two optimization methods are similar, the AIS are superior then EP in terms of computational time.

Table 1. The optimal new generators output using different optimization methods

	Initial	EP	AIS	PSO	TVA-REPSO
Gen 6 (MW)	--	84.141	84.140	76.323	76.320
Gen 7 (MW)	--	53.171	53.173	68.448	68.446
Power Loss (MW)	23.412	10.515	10.515	10.386	10.386
Total Gen (MW)	597.97	735.28	735.28	742.74	742.736
Power Loss ratio	3.9153	1.4301	1.4301	1.3984	1.3984
No. of Iteration		200	3	200	53
Computation Time(s)		165.65	25.61	309.27	68

On the other hand, the PSO and TVA-REPSO gave better results in finding the optimal size of generators compared to EP and AIS. The optimal size of generators obtained using PSO is 76.3239MW for bus 16 and 68.4480MW for bus 27 while for TVA-REPSO, the generators' optimal output are 76.3202MW and 68.4466MW for bus 16 and bus 27 respectively. By increasing the generator output at bus 27 and reducing the output at bus 16 as shown in Fig. 6, the power losses in the network, has reduced from 10.5151MW to 10.3864MW which is nearly to 1.3 percent power losses improvement.

Same as in EP and AIS cases, the PSO and TVA-REPSO also gave the similar performance in finding the generators' optimal generators' optimal output. However, the PSO algorithm needed until the maximum number of iteration before reaching the optimal value. Thus, the PSO will require a larger computing time in finding the generators' optimal results. On the other hand, the TVA-REPSO has obtained the optimal solution before the algorithm reaches the maximum iteration. From Table 1 results, the TVA-REPSO only required 68 seconds to gain the optimal value or 53 iteration compared to PSO that required 309.27 seconds. The computation time for PSO is higher than EP even though both methods run until the maximum iteration (200). It is due to the mutation process of PSO that required several steps (required to find P_{best} , G_{best} , V_{i+1}) compared to the EP algorithm. Furthermore, the AIS gave the smallest computing time compared to other algorithms where it only needed 25.61 seconds to get the optimal value.

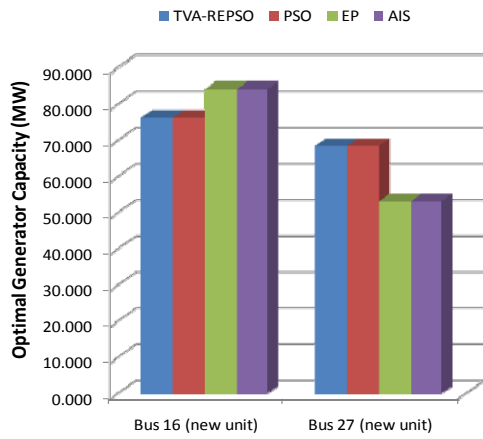

Fig.6. Total New Power Generation Capacity Bus 16 and 17

Fig. 7 shows the relationship between total electrical power generation (red bar) and the total power losses in the network (blue bar) with the losses ratio. Before the interconnection of new generator units, the ratio between the power losses and the total generation is 3.913 percent. However, after the interconnection of new generators, the ratio has reduced nearly to 1.43 percent for EP and AIS optimization methods and 1.3984 percent for the TVA-REPSO and PSO methods. The reduction of this ratio is not only due to the increment of power supplied, but also due to the reduction on power losses in the network. Since the losses ratio indicator for TVA-REPSO is lowest compared to EP and AIS and the computing time is better than traditional PSO, it can be concluded that the TVA-REPSO gives the best sizing on both generator units for reducing the losses in the network

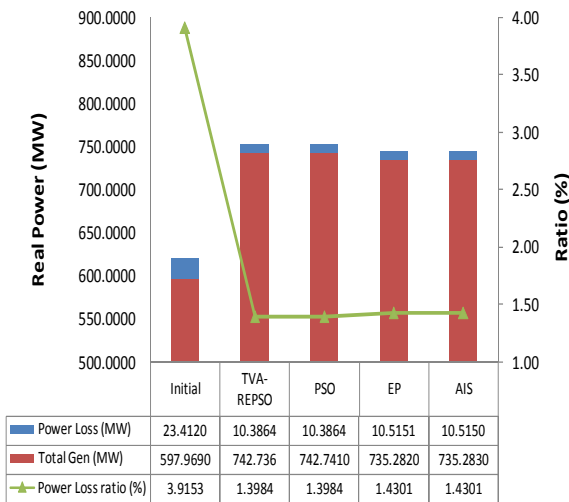

Fig.8: Total Power Generation vs Total Power Loss in South Sulawesi Transmission System

In order to check the robustness and the efficiency of new algorithm, the performance of TVA-REPSO in finding the minimum power losses is being tested for 30 times with different value of initial random number. Fig. 8 shows the convergence curve for TVA-REPSO algorithm in finding the generators' optimal output for 30 trials. From the results, TVA-REPSO obtained the optimal results before reached the maximum iteration as PSO does. Besides that, all 30 tests gave similar minimum power losses value for the transmission network with smaller standard deviation as shown in Table 2. Therefore, the TVA-REPSO can guarantee the consistency of the results obtained for each

time the algorithm is being used. As a conclusion, the TVA-REPSO is not only gave the lowest power losses and faster computing time, but it also gave a consistence results for every time the algorithm being used in solving the optimization problem.

Table 2. Overall performance of TVA-REPSO in finding minimum power losses in 30 trials

30 times		TVA-REPSO
Function values (Power Losses - kW)	Best	10386.44299
	Worse	10386.44358
	Mean	10386.44326
Standard Deviation		9.08218E-05

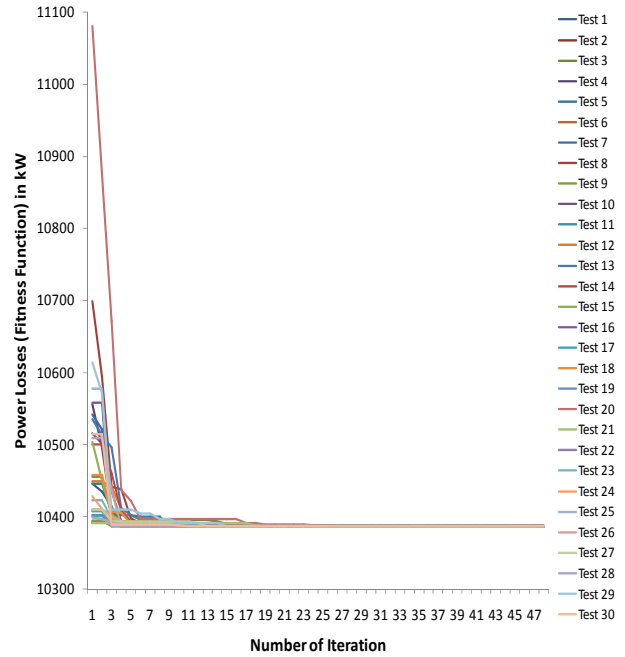

Fig.7. The performance of TVA-REPSO in finding the minimum power losses value

Conclusion

In this paper, four different optimization methods (TVA-REPSO, PSO, EP and AIS) are used to obtain the optimal power output for the new generators that will be installed in South Sulawesi Transmission System. The generators' location has been fixed by the government due to some factors which is in the Barru area (bus 16) and the Jeneponto Area (bus 27). Since the generators output will give an impact to the system, it is very important to have an optimal power output so that it will give positive impact to the system.

By implementing the optimization methods on the new generators' power output, the power losses in the transmission network have been reduced more than 50 percent. However, among these 4 methods, TVA-REPSO gave the best results compared to EP and AIS during searching the optimal value of generators where the generators size that given by TVA-REPSO gave the lowest power losses value in the system. Furthermore, the TVA-REPSO also gave less computing time and less number of iteration compared to PSO algorithm. With a very low standard deviation value which indicated to consistency in obtaining the similar results by the TVA-REPSO algorithm, it can be concluded that the novel algorithm that being proposed in this study is a superior method in solving the generators sizing problem for South Sulawesi Transmission System compared to PSO, EP and AIS algorithms.

Acknowledgements

The authors would like to thank Universiti Teknologi Malaysia, The State Polytechnic of Ujung Pandang and Government of South Sulawesi Indonesia for providing the financial and technical support for the research.

REFERENCES

- [1] Martinez Ramos J.L., Quintana V.H., Transmission power loss reduction by interior-point methods implementation issues and practical experience, *IEE Proc.-Gener. Transm. Distrib.*, 152 (2005), nr 1, 90-98.
- [2] R.S., Narasimham S.V.L., Ramalingaraju M., Optimal capacitor placement in a radial distribution system using Plant Growth Simulation Algorithm, *Electrical Power and Energy Systems* 33,(2011),1133–1139.
- [3] Abdullah N.R.H., Musirin I., Othman M.M.B., Transmission loss minimization using evolutionary programming considering UPFC installation cost, *International Review of Electrical Engineering (IREE)*, 5(2010), nr 3, 1189 – 1203
- [4] Mohammad K., Hossein S., Tohid B., Payam F., Noradin G., Solving Optimal Capacitor Allocation Problem using DE Algorithm in Practical Distribution Networks, *Przegląd Elektrotechniczny*, 88 (2012) nr (7a), pp. 90-93.
- [5] Mishara S., Reddy G.D., Rao P.E. and Santosh K., Implementation of New Evolutionary Technique for Transmission Loss Reduction, *IEEE Congress on Evolutionary Computation*,(2007), 2331 - 2336
- [6] Jangjit S., Kumkratug P., and Laohachai P., Reduction of Transmission line Loss by Using Interline Power Flow Controllers, *IEEE Electrical Engineering/Electronics Computer Telecommunications and Information Technology*, (2010).
- [7] Lee S.J., Location of Superconducting Device in a Power Grid for System Loss Minimization using Loss Sensitivity , Sensitivity, *IEEE Trans. On Applied Superconductivity*, 17, (2007), nr 2, 2351-2354.
- [8] Zhu J., Cheung K., Hwang D., Sadjadpour A., Operation Strategy for Improving Voltage Profile and Reducing System Loss, *IEEE Transactions on Power Delivery*, 25 (2010), nr 1, 390 – 397.
- [9] Rahli M. , Pirotte P. , Optimal load flow using sequential unconstrained minimization technique (SUMT) method under power transmission losses minimization, *Electric Power Systems Research*, (1999) , nr 52 , 61–64.
- [10] Esmine A.A., Torres G. L., Souza A.C.Z., A Hybrid Particle Swarm Optimization Applied to Loss Power Minimization, *IEEE Transactions On Power Systems*, 20 (2005) , nr 2, 859 – 862.
- [11] Ramana N.V. and Chandrasekar K., Multi-Objective Genetic Algorithm to mitigate the Composite Problem of Total Transfe Capacity, Voltage Stability and Transmission Loss Minimization, *North American Power Symposium*, (2007), 644 – 649
- [12] Montoya F.G., Ban R, Gil C., Esp A., Alcayde A. , Gomez J , Minimization of voltage deviation and power losses in power networks using Pareto optimization methods, *Engineering Applications of Artificial Intelligence* ,(2010), nr 23, 695–703
- [13] Bagriyanik F.G., Aygen Z. E., Bagriyanik M., Minimization of power transmission losses in series compensated systems using genetic algorithm, *International Review of Electrical Engineering (IREE)*, 6 (2011), nr 2, 810 - 817.
- [14] Kumar M.S., Renuga P., Application of bacterial foraging algorithm for enhancement of voltage stability using L-Index approach, *International Review of Electrical Engineering*, 6 (2010), nr 2, 922 – 928.
- [15] de Souza B.A., and de Albuquerque J.M.C., Optimal Placement of Distributed Generators Networks Using Evolutionary Programming, *IEEE CAPES (Brazilian Program for Graduate Personnel Improvement)*, (2006), 1 - 6
- [16] Kamari N.A.M., Musirin I. and Othman M.M., Application of Evolutionary Programming in the Assessment of Dynamic Stability, *The 4th International Power Engineering and Optimization Conference*, (2010), 43 – 48
- [17] John E. Hunt and Denise E. Cooke, Learning Using an Artificial Immune System, *Journal of Network and Computer Application*, Vol. 19, (1996), pp. 189 - 212
- [18] Medzhitov R., Janeway J., Innate Immunity The Virtues of a Non-clone System of Recognition , *Cell*, (1997), nr 91, 295 - 298
- [19] Hunt J., Timmis J., Cooke D., Neal M. and King C., The Development of an Artificial Immune System for Real World Applications, *In Artificial Immune System and Their Applications*, Springer-Verlag, (1998), 157-186.
- [20] Milanovi J.V., Lu J., Application Of Artificial Immune System For Detecting Overloaded Lines And Voltage Collapse Prone Buses In Distribution Network, *IEEE Bucharest Power Tech Conference*, (2009), 1 – 7
- [21] Kennedy J., Eberhart R.C., Particle Swarm Optimization, *IEEE International Conference on Neural Networks IV*, Piscataway, NJ 4, (1995) , 1942 – 1948
- [22] S. Sumathi, P. Surekha, Computational Intelligence Paradigms Theory and Application Using Matlab, *CRC Press Taylor And Perancis Group*, (2010), 162 – 167.

Authors:

Jasrul Jamani Jamian, Faculty of Electrical Engineering, Universiti Teknologi Malaysia, 81310 Johor Bharu, Johor, Malaysia. E-mail: jasrul@fke.utm.my.

Abdullah Asuhaimi Mohd Zin, Faculty of Electrical Engineering, Universiti Teknologi Malaysia, 81310 Johor Bharu, Johor, Malaysia. E-mail: abdullah@fke.utm.my.

Makmur Saini, Faculty of Electrical Engineering, Universiti Teknologi Malaysia, 81310 Johor Bharu, Johor, Malaysia. E-mail: makmur.saini@fkegraduate.utm.my.

Mohd Wazir Mustafa, Faculty of Electrical Engineering, Universiti Teknologi Malaysia, 81310 Johor Bharu, Johor, Malaysia. E-mail: jasrul@fke.utm.my.

Hazlie Mokhlis, Department of Electrical Engineering, Faculty of Engineering, University of Malaya, 50603 Kuala Lumpur, Malaysia. E-mail: hazli@um.edu.my.